

Round LED Flush Mount

501112
INSTALLATION SHEET

START FROM HERE

- Make sure power is completely off at the fuse box.
- Have your fixture installed by a qualified licensed electrician
- Prepare everything in a clear area.
- Wear gloves at all times during this installation.
- Read instructions carefully before you start assembly.
- Keep this instruction sheet for future reference.

Technical Support: 1-855-855-8926

Please Note:

- All Kuzco LED fixtures come with pre-wired LED module(s).
- Unless instructed to do so, please do not touch any part of the LED module(s) as any unnecessary contact with the module could cause permanent damage.
- For dimming, an ELV (Electronic Low Voltage) type of dimmer is required.

- 1.** Remove the fixture from its original packaging and remove the fixture mounting plate (1c) from within the canopy (2a) by unthreading nuts (2c). Attach the fixture mounting plate (1c) to the electrical junction box (1a) on the ceiling using the two screws (1e) provided in the hardware package.
- 2.** Attach the fixture to the mounting plate. First attach all wiring (1b) with the provided marrets (white to white "N", black to black "L", ground to ground "G"). Push the mounting plate screws (1d) through the holes in the back of the canopy (2b) so they are poking through into the center. Next, screw on the decorative nuts (2c) until the fixture is secured to the ceiling.
- 3.** Install the glass cover onto the fixture. Gently placing the glass cover (2d) inside of the lower metal inside clips (2a). Once the glass has been placed inside of the bracket, gently guide the ring bracket (2e) over the canopy top clip (2). Make sure that you align the clips (2e) with the three convexes (2) underside catch.
- 4.** You have now completed the installation of your fixture, please enjoy.

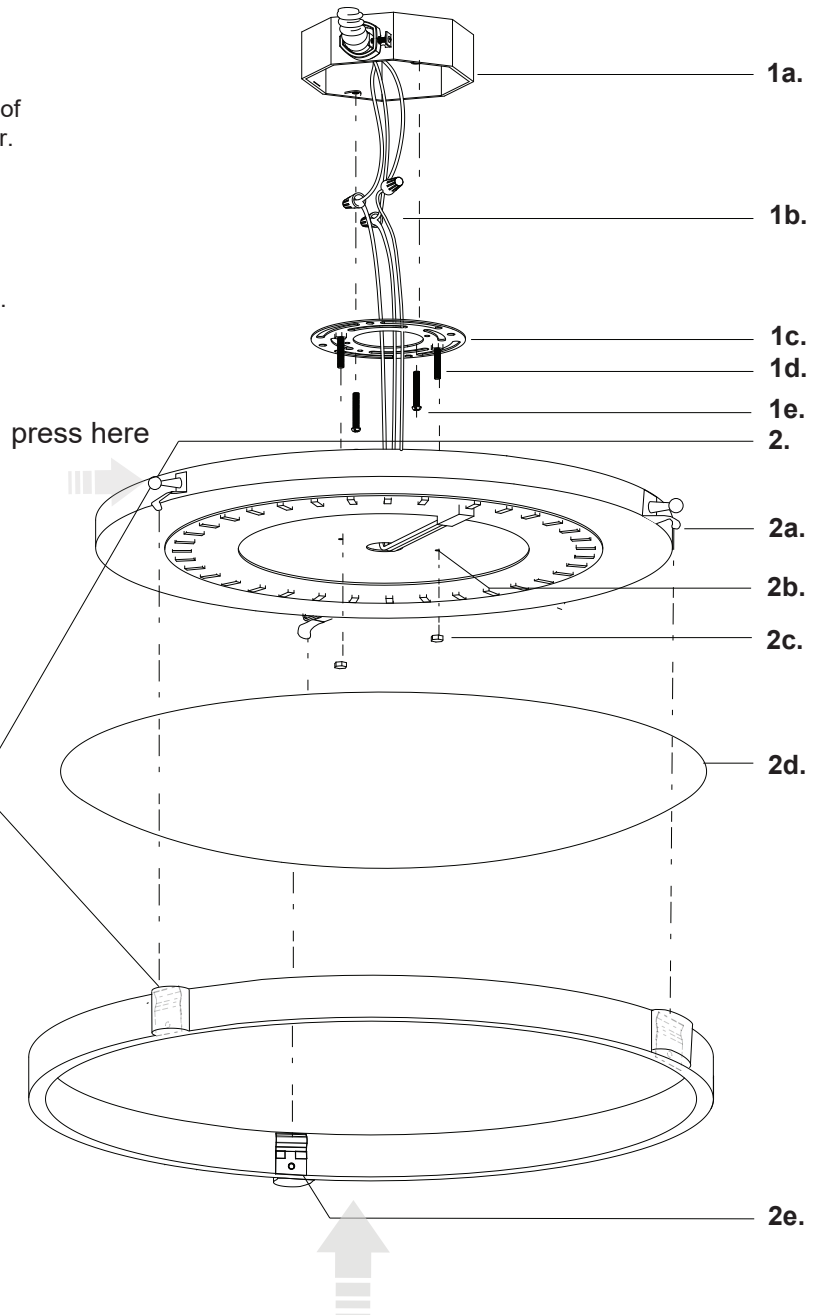

IMPORTANT, match the lower catches with the upper spring loaded knobs, this will properly secure the metal frame to the canopy.

KUZCO

19054 28th Avenue Surrey, BC Canada V3Z 6M3
T: 604 538 7162 TF: 1-855 85 KUZCO F: 604 538 7196
W: kuzcolighting.com
20181127